

1.8° Size 57mm High Torque Hybrid Stepping Motor

● General Specifications

Item	Specifications
Step Angle	1.8°
Step Angle Accuracy	± 5% (full step, no load)
Resistance Accuracy	± 10%(@20°C)
Inductance Accuracy	± 20%(1KHz)
Temperature Rise	80°C Max.(rated current,2 phase on)
Ambient Temperature	-20°C~+50°C
Insulation Resistance	100MΩ Min. ,500VDC
Dielectric Strength	500VAC for one minute
Shaft Radial Play	0.02Max. (450 g-load)
Shaft Axial Play	0.08Max. (450 g-load)
Max. radial force	75N (20mm from the flange)
Max. axial force	15N
Rotation	CW(See from Front Flange)



● Specifications

Model No.		Rated Voltage	Current /Phase	Resistance /Phase	Inductance /Phase	Holding Torque	# of Leads	Rotor Inertia	Weight	Detent Torque	Length
Single Shaft	Double Shaft	V	A	Ω	mH	kg-cm		g-cm ²	kg	kg-cm	mm
FL57STH41-1006A	FL57STH41-1006B	5.7	1	5.7	5.4	3.9	6	120	0.45	0.21	41
FL57STH41-2006A	FL57STH41-2006B	2.8	2	1.4	1.4	3.9	6				
FL57STH41-3006A	FL57STH41-3006B	1.9	3	0.63	0.6	3.9	6				
FL57STH41-2804A	FL57STH41-2804B	2	2.8	0.7	1.4	5.5	4				
FL57STH51-1006A	FL57STH51-1006B	6.6	1	6.6	8.2	7.2	6	275	0.65	0.36	51
FL57STH51-2006A	FL57STH51-2006B	3.3	2	1.65	2.2	7.2	6				
FL57STH51-3006A	FL57STH51-3006B	2.2	3	0.74	0.9	7.2	6				
FL57STH51-2804A	FL57STH51-2804B	2.3	2.8	0.83	2.2	10.1	4				
FL57STH56-1006A	FL57STH56-1006B	7.4	1	7.4	10	9.0	6	300	0.7	0.4	56
FL57STH56-2006A	FL57STH56-2006B	3.6	2	1.8	2.5	9.0	6				
FL57STH56-3006A	FL57STH56-3006B	2.3	3	0.75	1.1	9.0	6				
FL57STH56-2804A	FL57STH56-2804B	2.5	2.8	0.9	2.5	12.6	4				
FL57STH76-1006A	FL57STH76-1006B	8.6	1	8.6	14	13.5	6	480	1	0.68	76
FL57STH76-2006A	FL57STH76-2006B	4.5	2	2.25	3.6	13.5	6				
FL57STH76-3006A	FL57STH76-3006B	3	3	1	1.6	13.5	6				
FL57STH76-2804A	FL57STH76-2804B	3.2	2.8	1.13	3.6	18.9	4				
FL57STH84-4006A	FL57STH84-4006B	2.8	4.0	0.7	1.5	18	6	520	1.2	0.8	84
FL57STH115-2804A	φ 8 SHAFT	5.88	2.8	2.1	10	30	4	650	1.8	1.0	115

● Dimensions

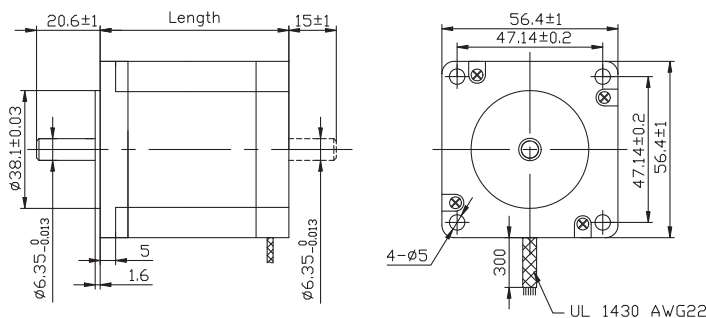

● Wiring Diagram

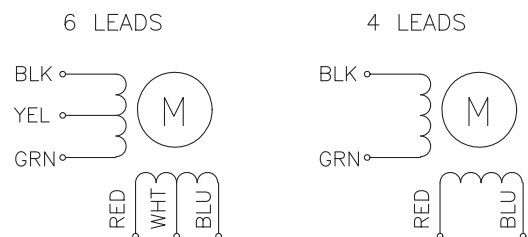



● Pull-out Curve

FL57STH41-1006A

VM: 30VDC I:1A /Phase ,half step,Chop driver

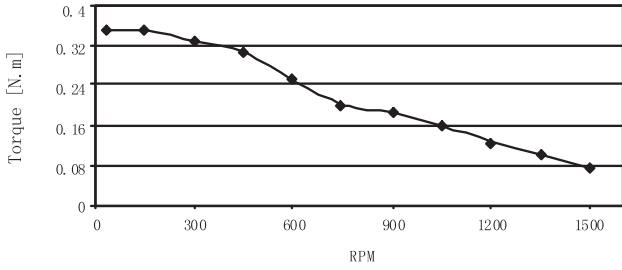

FL57STH41-2006A

VM: 30VDC I:2A /Phase ,half step,Chop driver

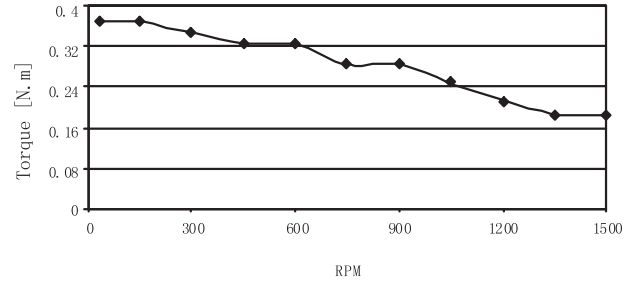

FL57STH41-3006A

VM: 30VDC 3A /Phase,half step,Chop driver

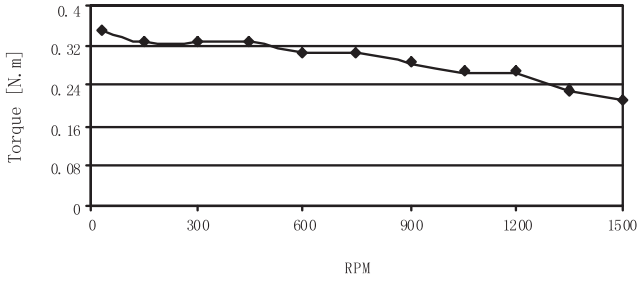

FL57STH41-2804A

VM: 30VDC I:2.7A /Phase,half step,Chop driver

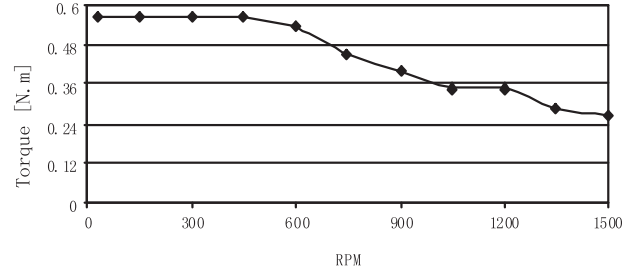

FL57STH51-1006A

VM: 30VDC 1A /Phase,half step,Chop driver

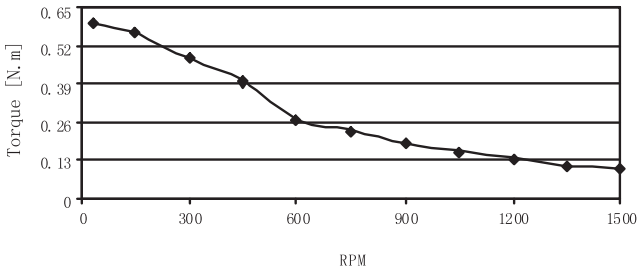

FL57STH51-2006A

VM: 30VDC I:2A /Phase,half step,Chop driver

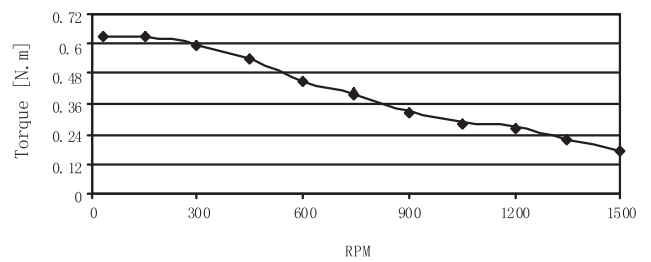

FL57STH51-3006A

VM: 30VDC I:3A /Phase ,half step,Chop driver

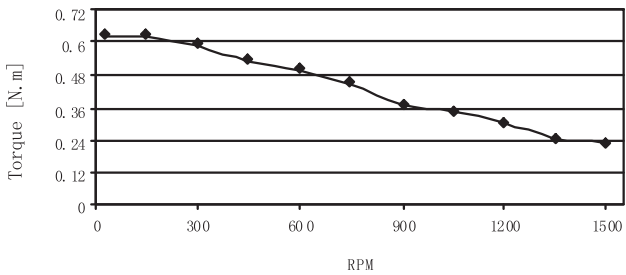

FL57STH51-2804A

VM: 30VDC I:2.7A /Phase,half step,Chop driver

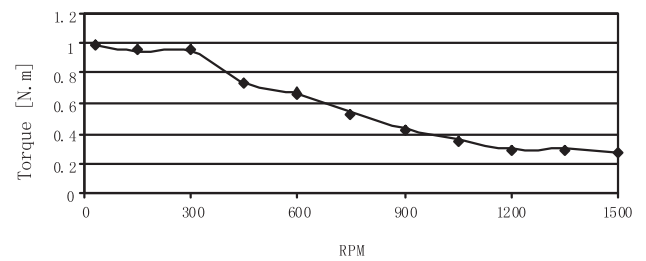

● Pull- out Curve

FL57STH56-1006A
VM: 30VDC I:1A /Phase, half step, Chop driver

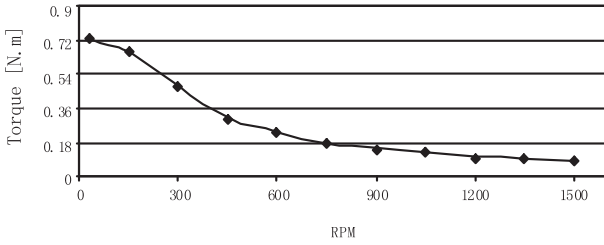

FL57STH56-2006A
VM: 30VDC I:2A /Phase, half step, Chop driver

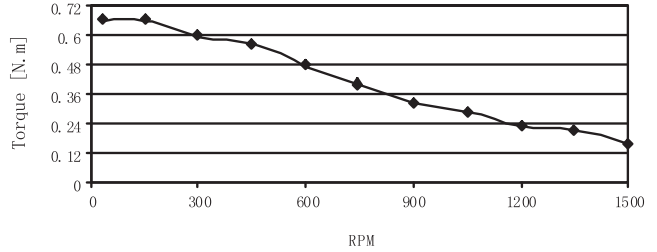

FL57STH56-3006A
VM: 30VDC I:2.7A /Phase, half step, Chop driver

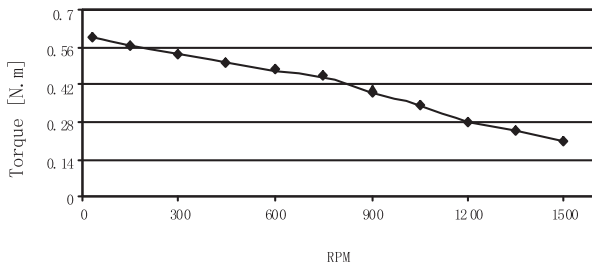

FL57STH56-2804A
VM: 30VDC I:2.7A /Phase, half step, Chop driver

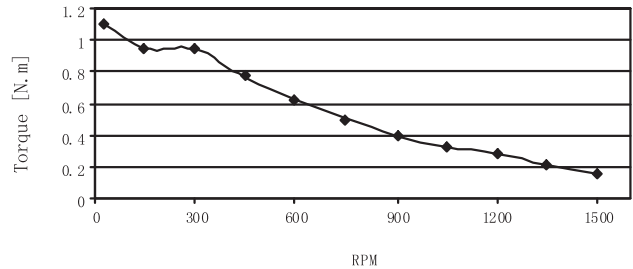

FL57STH76-1006A
VM: 30VDC I:1A /Phase, half step, Chop driver

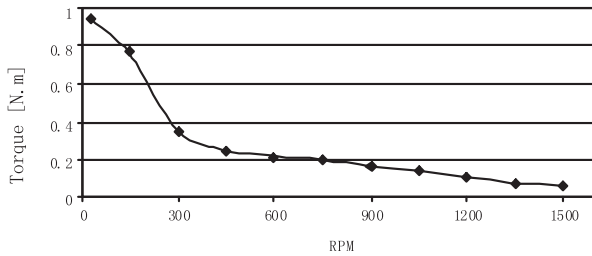

FL57STH76-2006A
VM: 30VDC I:2A /Phase, half step, Chop driver

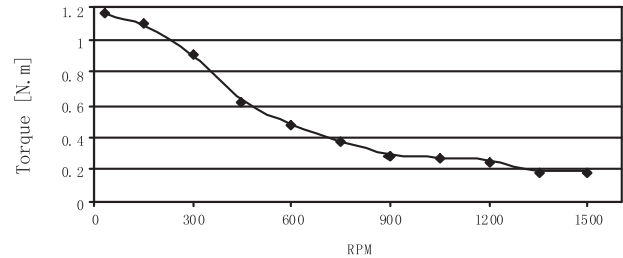

FL57STH76-3006A
VM: 30VDC I:2.7A/Phase, half step, Chop driver

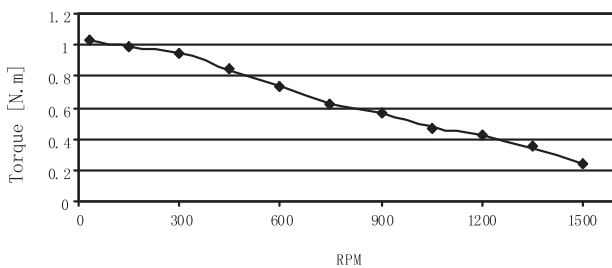

FL57STH76-2804A
VM: 30VDC I:2.7A /Phase, half step, Chop driver

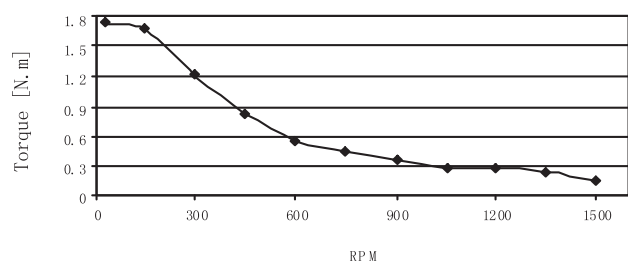

*This motor can be designed & manufactured with customized request.